

# KOVÁCSOLT TŰSKÉK

Gyártó : Battista Porteri S.r.l. Olaszország

Érvényes : 2011.11.01.-től visszavonásig

51070

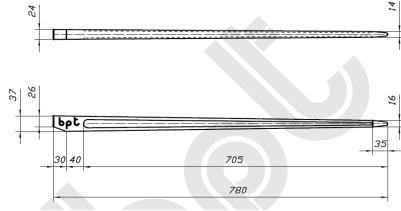

53090

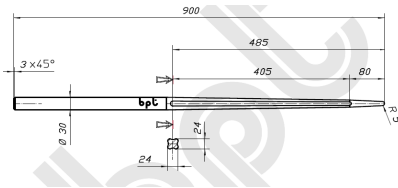

53 441

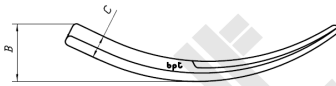

53 442 LO-MA

53 442 UNHZ

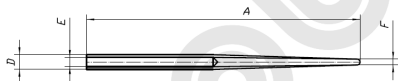

53 443

COD.	A	B	C	D	E	F
53441	540	116	47	30	19	12
53442	600	142	56	37	26	18
53443	600	145	56	44	27	23

53 515

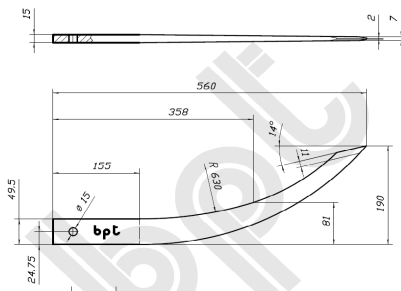

51 020

COD.	A	B
51020	M20x1.5	16
51022	M22x1.5	18
51028	M28x1.5	24

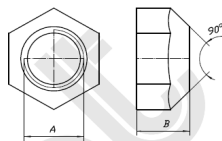

51 022

51 028

51 434

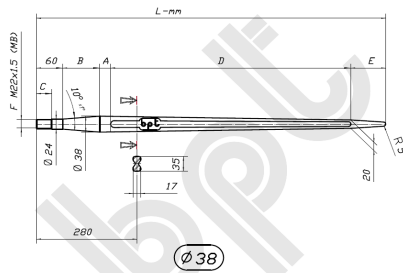

51 444 TRAC-LIFT

COD.	L	A	B	C	D	E	F (MB)
51434	680	30	70	40	450	80	22x1.5
51444	800	40	70	40	560	80	22x1.5

51 435 TRAC-LIFT

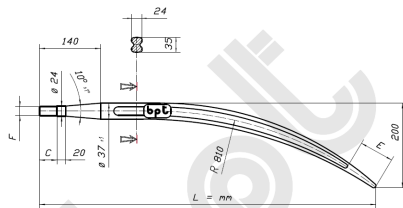

51 445

COD.	L	A	G	C	D	E	F
51435	660	-	170	40	-	80	22x1.5
51445	770	-	200	40	-	80	22x1.5

51 448

51 450

51 452

51 454 TRAC-LIFT

51 458

51 464

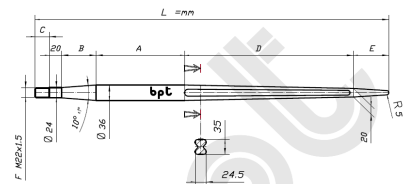

COD.	L	A	B	C	D	E	F
51448	900	160	70	40	530	80	22x1.5
51450	950	210	70	40	530	80	22x1.5
51452	1000	260	70	40	530	80	22x1.5
51454	1100	360	70	40	530	80	22x1.5
51458	1200	460	70	40	530	80	22x1.5
51464	1400	660	70	40	530	80	22x1.5

52 555

52 557

52 559

52 561

52 563

52 565

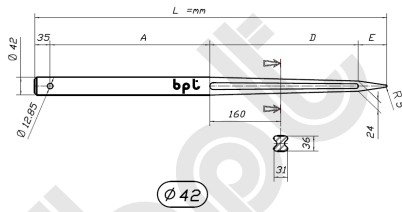

COD.	L	A	B	C	D	E	F
52555	800	120	-	-	580	65	-
52557	900	220	-	-	580	65	-
52559	1000	320	-	-	580	65	-
52561	1100	420	-	-	580	65	-
52563	1200	520	-	-	580	65	-
52565	1400	720	-	-	580	65	-

51 555

51 557

51 559

51 561

51 563

51 565

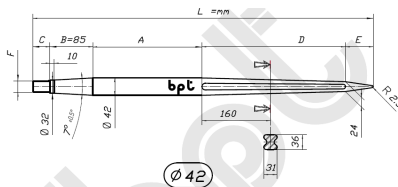

COD.	L	A	B	C	D	E	F
51555	810	35	85	45	580	65	28x1.5
51557	900	125	85	45	580	65	28x1.5
51559	1000	225	85	45	580	65	28x1.5
51561	1100	325	85	45	580	65	28x1.5
51563	1200	425	85	45	580	65	28x1.5
51565	1400	625	85	45	580	65	28x1.5

51 231

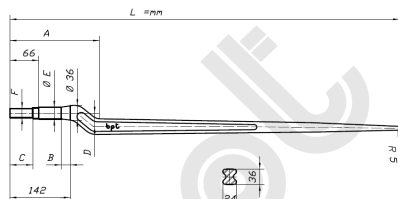

COD.	L	A	B	C	D	E	F
51231	880	205	24	52	32	28	22x1.5

51 058

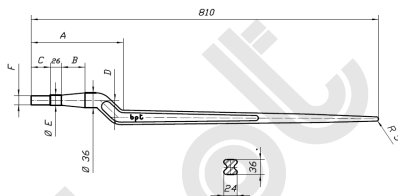

COD.	L	A	B	C	D	E	F
51058	880	213	55	44	41	25	22x1.5

50 880

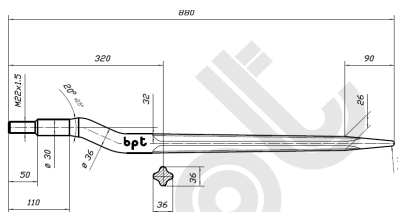

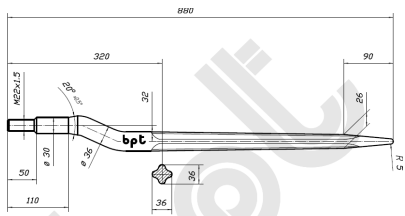

58 080

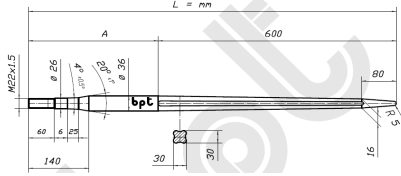

COD.	L	A
58080	800	200

Ø 36

58 110

58 140

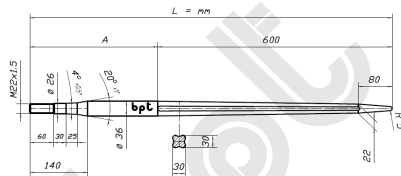

COD.	L	A
58110	1100	500
58140	1400	800

Ø 36

51 576

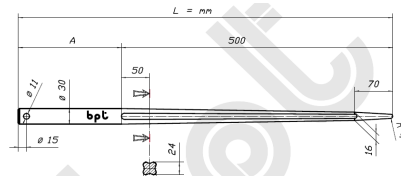

COD.	L	A
51576	770	270

55 008

55 011

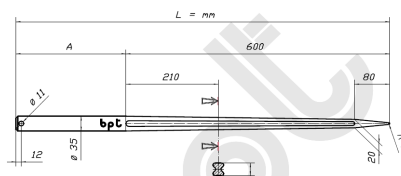

COD.	L	A
55008	850	250
55011	1150	550

58 230

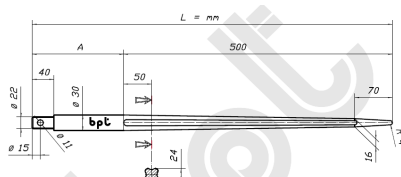

Ø 30

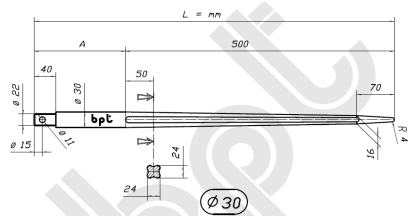

COD.	L	A
58230	820	320

58 235

51 586

51 512

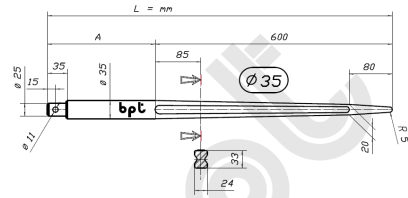

COD.	L	A
58235	820	220
51586	850	250
51512	1200	600

58 615

58 614

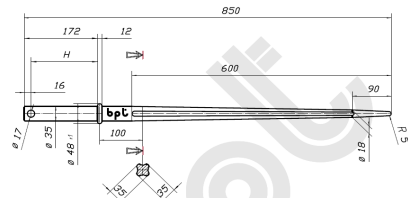

COD.	H	
58615	141	EMILY
58614	155	AGRAM

55 025

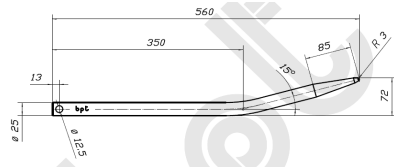

51 654

51 625

51 644

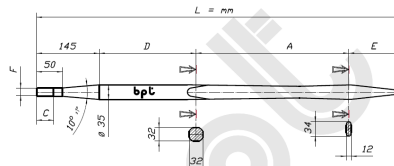

COD.	L	A	B	C	D	E	F
51654	1100	460	-	40	375	120	20x1.5
51625	1250	460	-	40	525	120	20x1.5
51644	1400	460	-	40	675	120	20x1.5

51 360

51 680

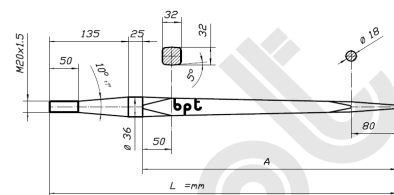

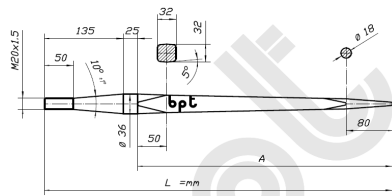

COD.	L	A
51360	600	440
51680	680	520

51 320

51 329

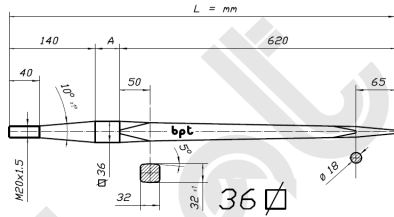

COD.	L	A
51320	800	40
51329	900	140

51 350

51 455

51 425

51 460

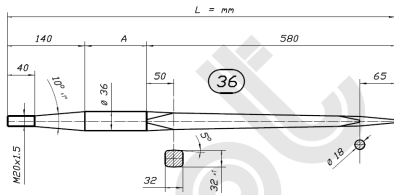

COD.	L	A
51350	1000	280
51455	1100	380
51425	1250	530
51460	1400	680

51 605

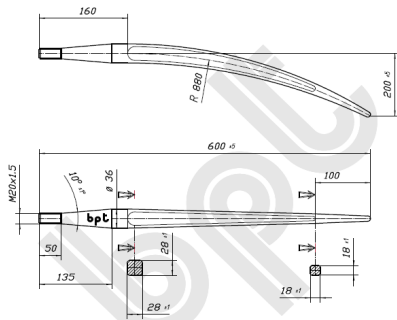

51 600

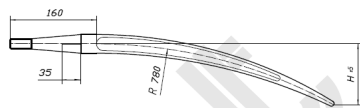

51 688

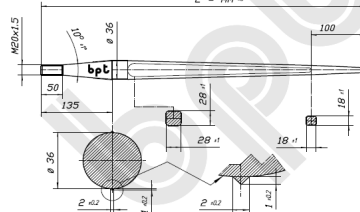

51 800

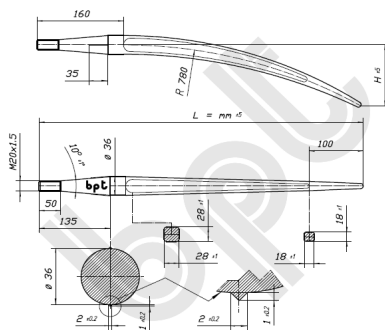

COD.	L	H
51600	600	85
51688	680	135
51800	800	205

50 824

50 822

50 820

50 920

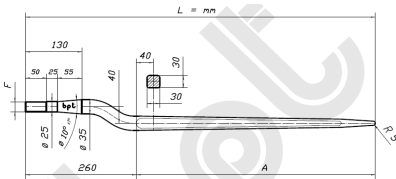

COD.	L	A	F
50824	820	560	24x1.5
50822	820	560	22x1.5
50820	820	660	20x1.5
50920	920	660	24x1.5

51 946

51 144

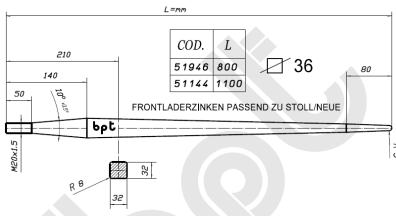

51 944

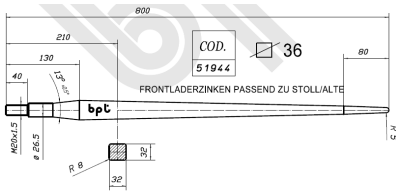

54 582

54 598

54 511

54 512

54 514

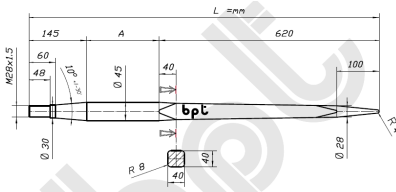

COD.	L	A
54582	820	55
54598	980	215
54511	1100	335
54512	1250	485
54514	1400	635

54 502

54 508

54 551

54 520

54 540

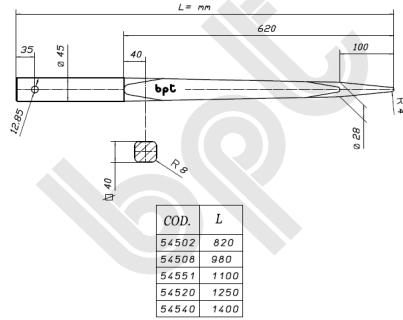

55 082

55 098

55 111

55 014

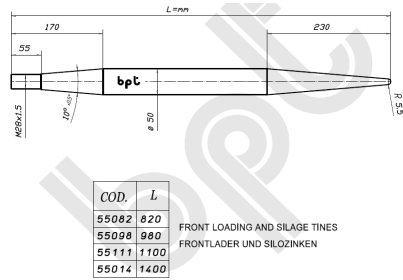

55 582

55 598

55 140

55 512

55 514

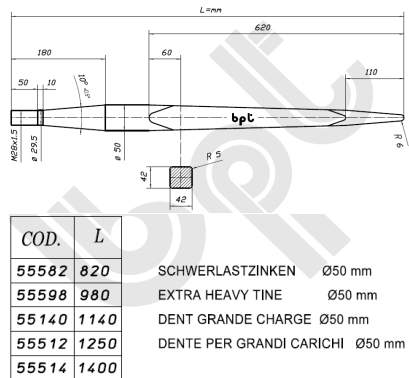

## ILLESZTŐPERSELYEK TÜSKÉKHEZ

52 223

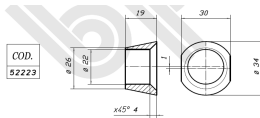

52 080

52 036

52 042

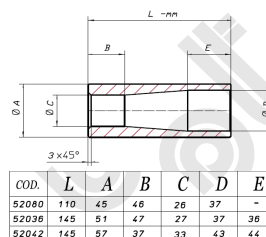



52 042/CF

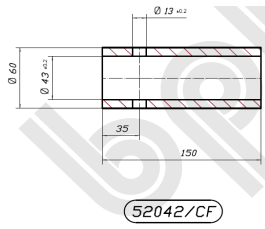

52 080/KV

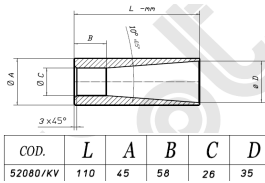

COD.	L	A	B	C	D
52080/KV	110	45	58	26	35

50 080/S

50 080/S/50

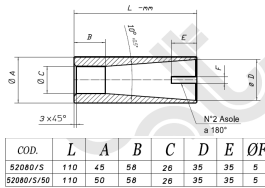

COD.	L	A	B	C	D	E	ØF
52080/S	110	45	58	26	35	35	5
52080/S/50	110	50	58	26	35	35	5

52 045

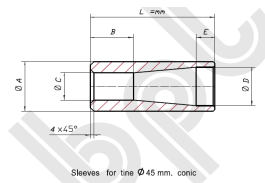

Sleeves for line Ø 45 mm. conic

COD.	L	A	B	C	D	E
52045	145	60	50	33	46.5	22

52 045/CF

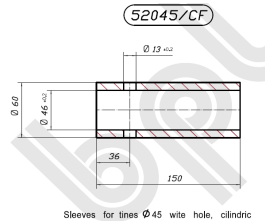

Sleeves for lines Ø 45 with hole, cilindric

52 050/70

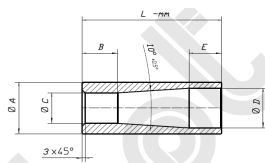

52 050/76

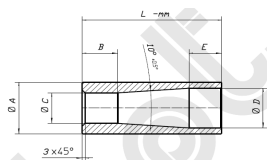

COD.	L	A	B	C	D	E
52050/70	170	70	42	32	51	25
52050/76	170	76	42	32	51	25

## HEGESZTHETŐ MUNKAESZKÖZ-FELFOGATÓK

53 094

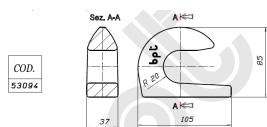

53 092

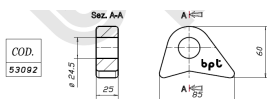

85 010

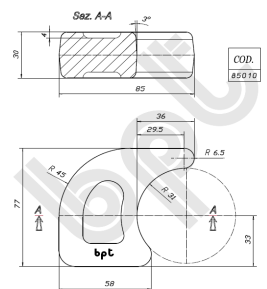

51 912

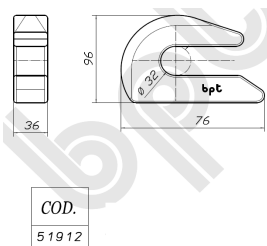

# Kanálkörmök

53 061

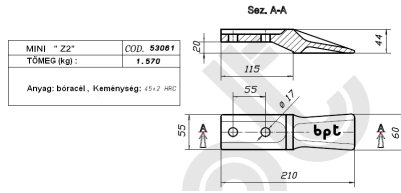

53 062

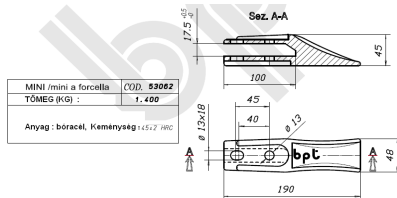

53 440

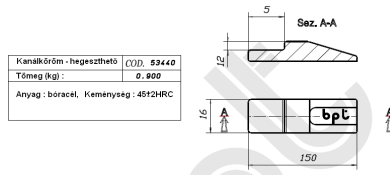

53 080

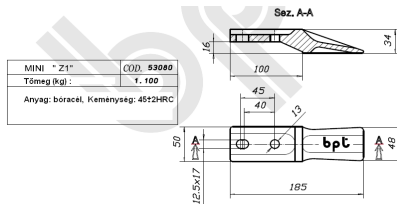

60 030

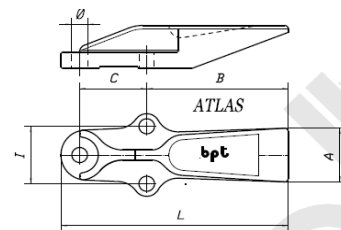

60 031

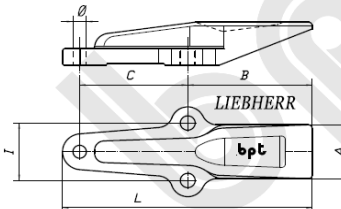

Anyag: bóracél Keménység: 45±2 HRC

MODELLO	COD.	L	A	B	C	I	∅	Kg
ATLAS	060030	305	75	195	90	70	21	5.5
LIEBHERR	060031	335	75	167	145	80	18	5.5